

Article number: 2301065931
Description: E+G Handwheel
VBR.4/370

Measures

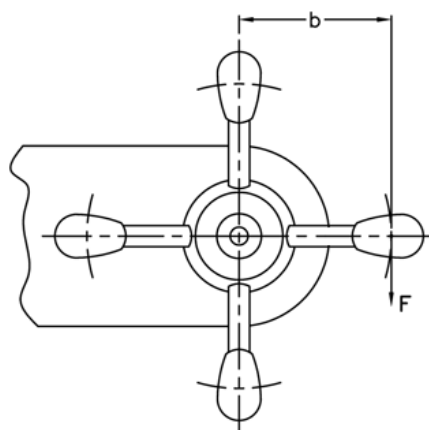
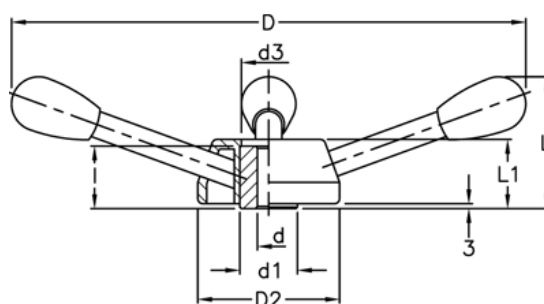

$$C[N \cdot m] = F[N] \cdot b[m]$$

C (N m) = 195
D = 363
d1 = 35
D2 = 86
d3 = 34
d H9 = 10
l = 38
L = 90

L1 = 42